

The Finishing Touch

A How-to and
Idea Handbook on
Indiana Limestone
Standard Products

Indiana
Limestone
Institute

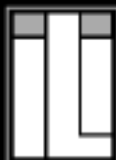

The coordinating agency
for information, education,
and technical data for
Indiana Limestone, the
Nation's Building Stone.

THE PURPOSE OF THE INDIANA LIMESTONE INSTITUTE

The Institute serves the construction industry, the architectural profession and the limestone industry as a coordinating agency for the dissemination of accurate, unbiased information on Indiana Limestone standards, recommended practices, grades, colors, finishes, and all technical data required for specifying, detailing, fabricating, and erecting Indiana Limestone.

SERVICES AVAILABLE TO ARCHITECTS

In order to facilitate the selection of limestone grades, colors, and finishes, as well as advise on recommended practices, the Indiana Limestone Institute maintains a complete staff of consultants who are available upon request to help architects, designers, and specifiers with any technical problem.

TECHNICAL DATA

The Institute has on file the results of many years of research, experience, and case histories in the fabrication and use of Indiana Limestone. This information along with many supplemental technical papers and the Indiana Limestone Handbook is immediately available upon request.

TO OBTAIN ASSISTANCE

If you are an architect, designer, specifier, engineer, builder or interested building owner, simply telephone the Indiana Limestone Institute office (812—275-4426) or send a card or letter requesting the assistance you require. Your inquiry will receive immediate action either by return telephone call or mail, or by a personal visit in your office by an Institute representative, if necessary.



Indiana Limestone Institute of America, Inc.

Suite 400
Stone City Bank Building
Bedford, Indiana 47421
812/275-4426
www.iliai.com

Contents

- Production Diagram—p. 4
- Indiana Limestone Trim—5, 6, 7, 8
- Coursed Ashlar—9, 10
- Non-machined Ashlar—11
- Specialty Items—12
- Joint Styles—13
- Mortars—13, 14
- Cold Weather Masonry—14
- Storage & Handling—15
- Waterproofing—15
- Lintel Table—16
- Coursing Table—17
- Thermal Properties—18
- Color Value—19
- Geological Formation—20
- Physical Properties—20
- Chemical Analysis—21
- Product Description—21
- Colors of Indiana Limestone—21
- Specifications for Ashlar Stone Veneer—22, 23

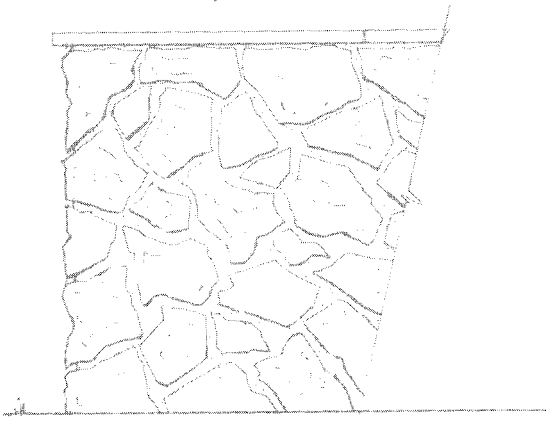
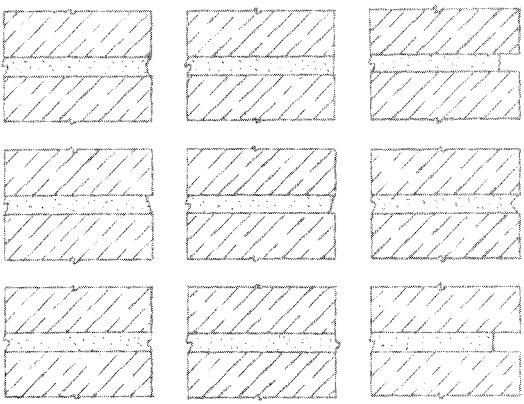
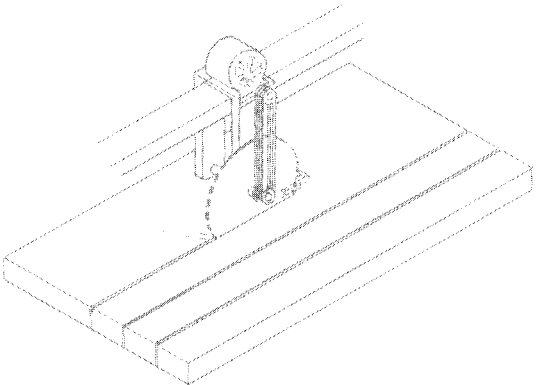
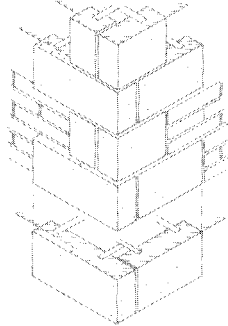
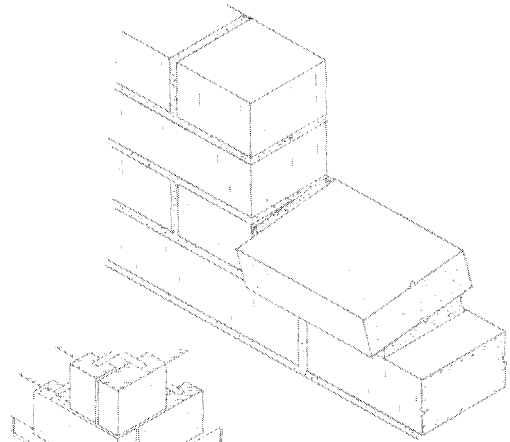

Stone is separated from the ledge by channelling machines and wire saws. After the "cut" is turned, (A) blocks of handleable size are produced by drilling and splitting with wedges. These blocks are further reduced in size by "slabbing" (B) in gang saws. Slabs are cut by diamond circular saws (C) into sawed-stone items for sills and coping. Some slabs are sawed to proper heights and widths for splitting (D) the popular "splitface" ashlar. By either hand or machine, the splitface stone may be "pitched" (E) to form a rougher look called "rockface" or "pitchface".

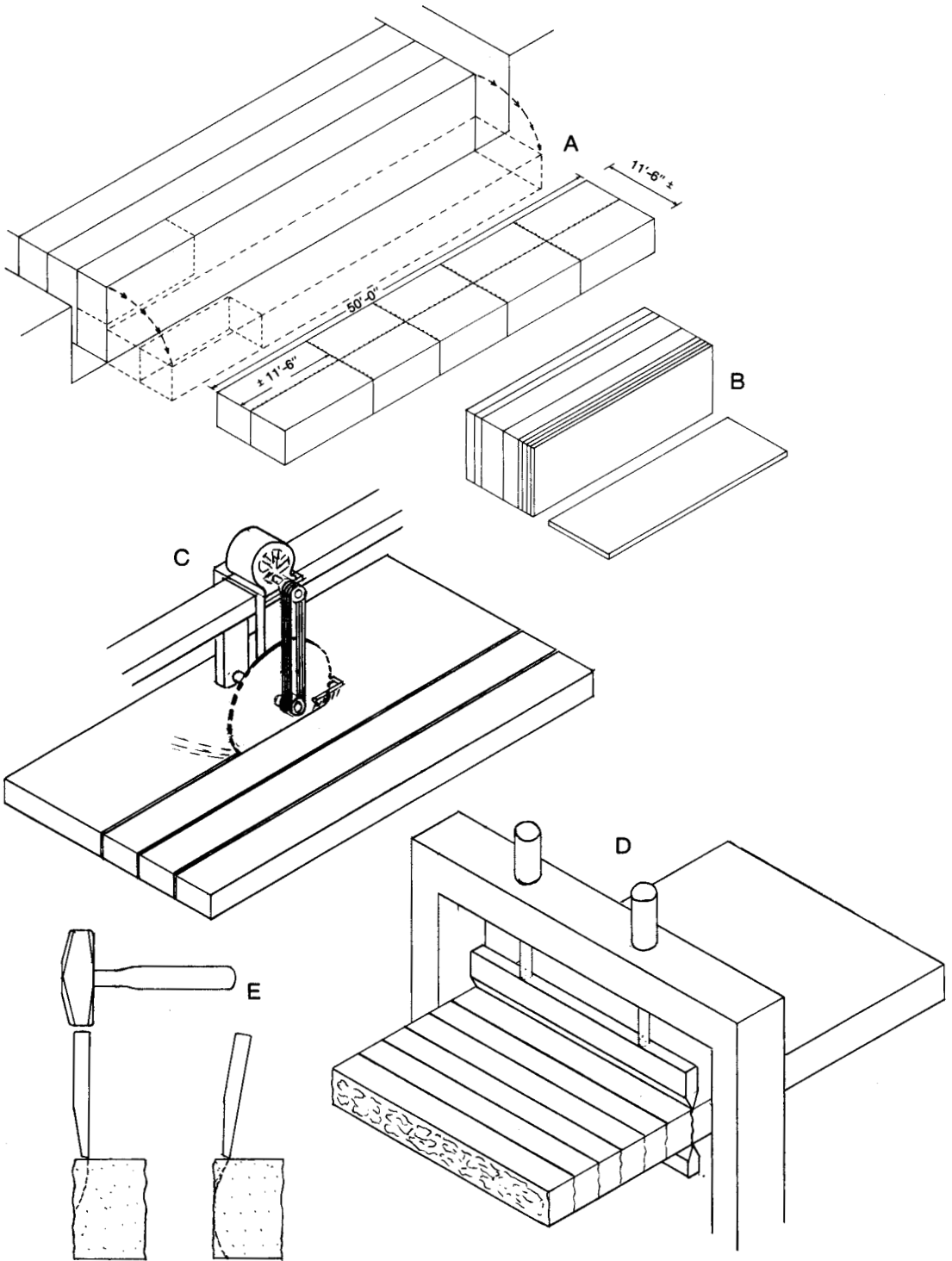

Indiana Limestone Trim

The qualities of Indiana Limestone and the forms in which it can be produced have served American architecture for more than a century. Hundreds of major buildings are built with Indiana Limestone every year, but as much stone is used as trim and ashlar in "light" construction as that installed in highrise and monumental buildings.

Trim materials for offices, stores, apartments, residential structures and similar light construction are familiar, inexpensive and easy to use. Much stone of this type is purchased for purely aesthetic reasons, but Indiana Limestone trim serves sound economic purposes as well.

The first section in this book deals with window and door trim—sills, headers and jambs. Building openings are particularly delicate areas, and where they are protected from weather and eccentric movement by solid materials like Indiana Limestone, a measurable reduction in stress-related failures occurs. Complicated connections between unlike materials are eliminated and construction proceeds more rapidly. Compression and other stresses in masonry walls are more equally distributed with the use of properly sized limestone headers. Limestone sills protect vital horizontal surfaces by incorporating a minimum number of vulnerable joints. Limestone jambs resist lateral movement occurring near openings.

Such openings are structurally sound. The use of stone trim also gives the opening a visual and aesthetic reason for being. It clearly marks the interruption of the building walls so that a window ceases to be merely a hole punched in the wall.

Where brick is the primary building material, the judicious use of Indiana Limestone trim reduces the monotony of color often presented by clay products. Limestone's light-neutral colortones contrast with darker brick, offering not merely a pleasing appearance but economy and durability plus the advantage of a familiar, solid material. When used with limestone ashlar unit walls, trim items offer the contrast of smooth finish with the rugged surface of split-face. The larger sizes of limestone sills and coping reduce total joint area and thus reduce the possibility of leakage encountered in built-up brick sills and wall-tops.

In architectural projects where stone use is limited to sawed stone coping and sills, a simple note on drawings indicating the usage areas, and identifying the material as "sawed Indiana Limestone sills" or "sawed Indiana Limestone coping" will often eliminate the need for a more elaborate specification such as that shown on pages 22-23.

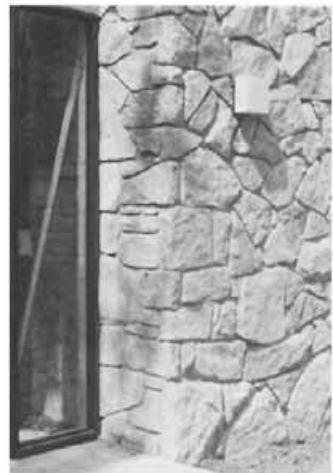

Indiana Limestone Trim Window Sills, Coping & Wall Caps

Most exterior walls have two weather surfaces. A wall's exterior vertical face receives most of the architectural attention. It is the element which usually defines the building for the majority of people who go past it but never enter it.

The wall's other weather surface is its top—a parapet, a metal gravelstop coping, the top course of the major wall material. Although this horizontal weather surface is never seen by the building's occupants, all too often it defines the building for them as a troublesome, leaky place in which to live or work.

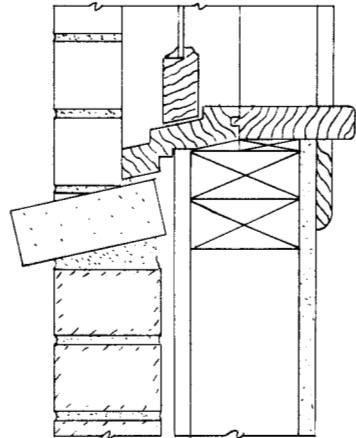

Flat sawed-stone sills may be tipped for wash surface, or set flat in windows or as capping for wing-wall extensions. This is particularly effective when used as band course at sill level. Dealer or his supplier can provide specially sawed shapes where checked-out areas are needed.

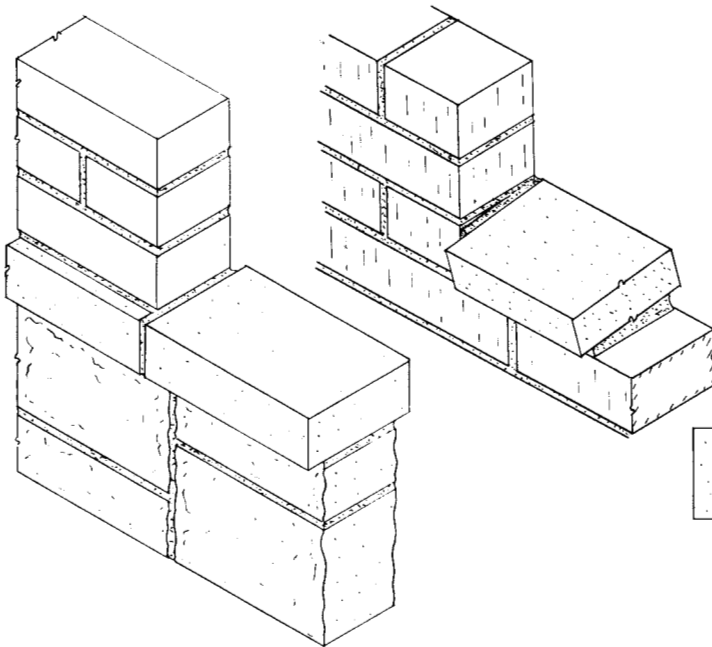

Walls of both masonry units and monolithic materials often give trouble as a result of leaks at the top. Although the engineering reasons for failure differ for different materials, the basic causes are expansion-contraction variants, weathering of joint materials and the tendency of cap materials to warp, creep, shrink or bend.

Coping of Indiana Limestone overcomes most of these inherent causes of walltop failures. The material has a low coefficient of expansion and can be expected to remain where it is placed regardless of the movement of other materials. Because it is available in comparatively long runs, limestone requires fewer joints, and those joints can be treated with more resistant materials at lower total cost.

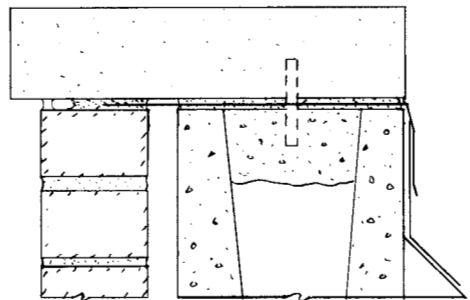

Parapet Coping

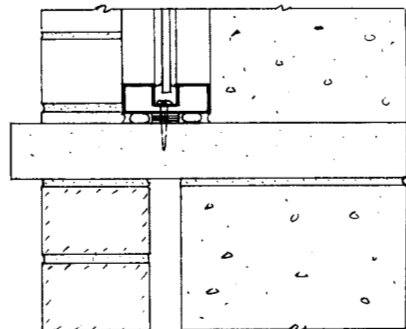

**"Through-the-Wall" Sill
for Fixed Window**

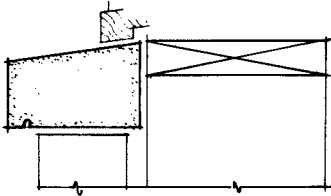
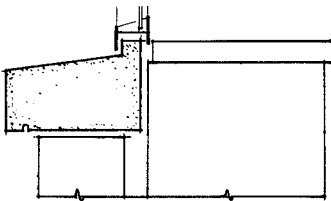
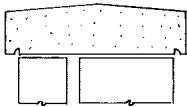
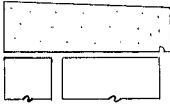
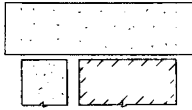
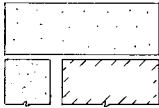

Sill and wall cap (coping) stone is available in a wide range of thicknesses and widths. The most popular thickness is 2 1/4". Four other thicknesses, 1 1/2", 2", 3" and 4", are also available. Standard widths include 5", and from 6" to 2'-0" in 2" increments from most suppliers. Lengths may be specified (such orders are for "sawed-six-sides") or stone may be ordered random lengths, (sawed-four-sides). These usually average 3'-0" to 6'-0", and require jointing to fit at the job. Many suppliers offer sawed stone items with one long edge rockfaced.

Sawed stone items will serve also for use as door sills, window and door lintels, and complete window surrounds. An imaginative designer, builder or mason can improve both.



COMPLEX SHAPES IN SILLS AND COPING AVAILABLE FROM MOST SUPPLIERS.

Most limestone suppliers and their dealers will fabricate specialty needs on a custom basis. Often, special fabrication will not be required where sizes are such that standard sections can be used. The mason can saw or cut many stone items from extra lengths of sill or coping stock. If special shapes like washed, dripped or molded sills and coping are needed they can be provided by the dealer or his supplier.

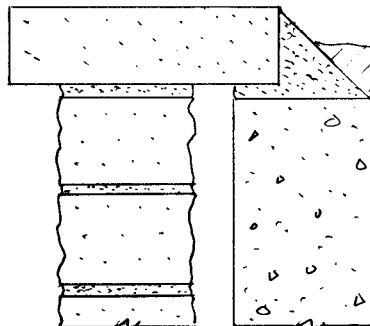
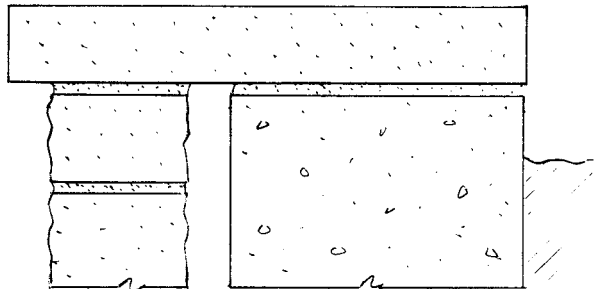

Sawed-stone used as coping. May be used in commercial applications with BU roof, or as cap for retaining walls and planters. A mortar ramp will provide a wash surface and retain soil near the tops of planters.

the appearance and performance of masonry buildings at little or no additional cost with the use of Indiana Limestone standard products.

These products are available directly from the stock of most suppliers, and are price-list items quoted either by the lineal foot or the cubic foot. Sills and other trim items with other than rectangular profiles are also available; sills with wash surfaces, drip molds, non-standard sizes and curved profiles can be furnished by most suppliers and will be quoted on request.

Quoined corners may be used in a purely decorative way, or to suggest an architectural style, but they can also serve a very sound structural purpose. Building corners are strengthened by the additional bulk of quoin stones when well cramped and anchored. Their use will minimize settlement cracks in corners and returns. Butt-end quoins can be cut on the job from sill stock.

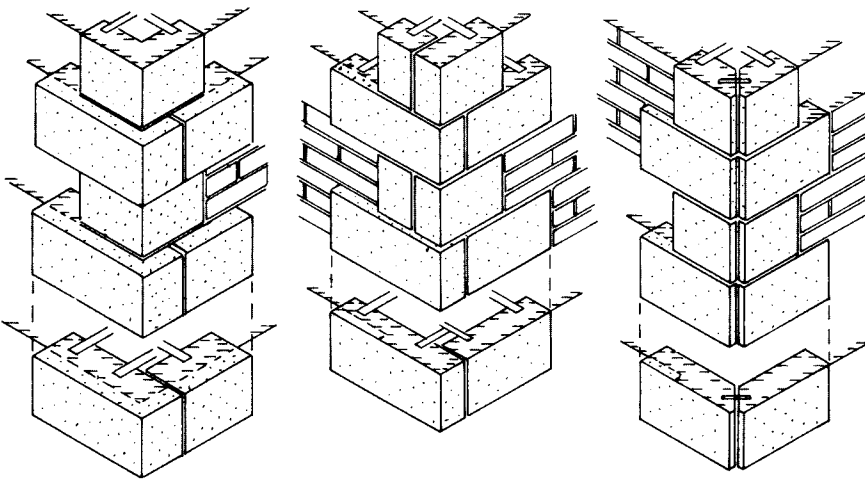

Quoins jobcut from sawed-stone items. Quoins may be veneer with back surfaces in a plane with the backs of brick or veneer stone, or may be bulkier stones projecting into the backup for additional stability.



Front-facing quoins are prime locations for date stones or street addresses. Most suppliers can arrange lettering, numbers and other inscriptions.

Coursed and Other Machine-Cut Ashlar

The aesthetic and economic advantages of Indiana Limestone are more obvious in the use of coursed ashlar than in any other application. Depending on the quantity and sizes, limestone ashlar is comparable to brick in its delivered cost. It is set in exactly the same manner as any other unit masonry material by the same trades using the same tools. Due to its larger individual size, the mason setting limestone ashlar can achieve better square-foot production.

After the owner occupies his building, the advantages are even more apparent. The structure gleams with the light-neutral color tones of this natural material. Instead of a wall of 20% joint area, limestone ashlar sizes provide for as little as 5% joint area, and the weight of the individual pieces compresses the mortar insuring against failure. Ashlar pieces may act as sills, headers and jambs without the requirement for metal angle support. Standard sized sawed stone may be used for a contrasting finish in colors similar to the ashlar products.

Coursed ashlar and trim items are priced by units of tons or lineal or square feet, and are available from a network of dealers in major cities and many smaller ones.

These veneer stones are machine fabricated to accurate course heights which make a predictable pattern, or "course out" to form level beds for openings and wall tops. The standard heights or "rises" are $2\frac{1}{4}$ " , 5" and $7\frac{3}{4}$ ". These rises, plus $\frac{1}{2}$ " mortar joints, allow the mason to set a random pattern of pleasing appearance

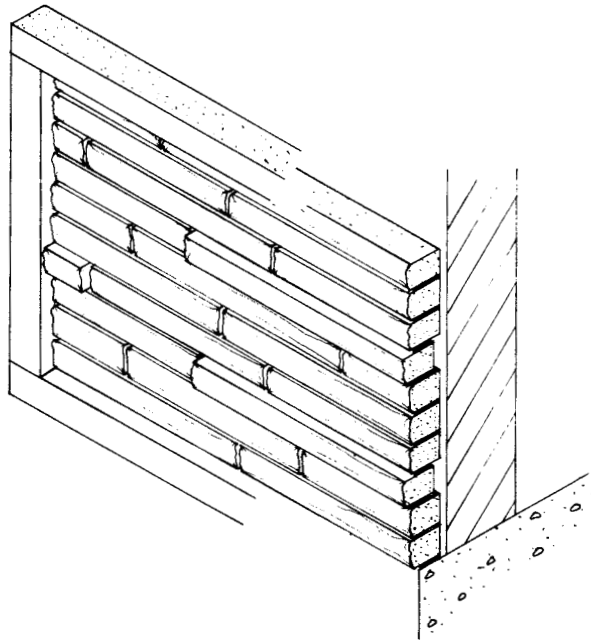
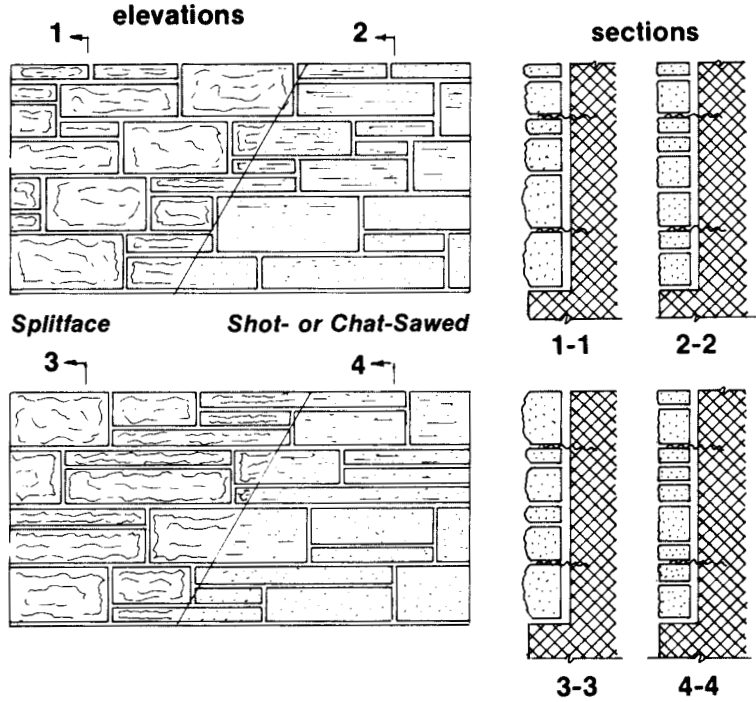

Any of the standard course heights may be used by itself as single-rise ashlar. Ordinarily, the $2\frac{1}{4}$ " height is used for this purpose. It produces an attractive wall emphasizing horizontal lines. An occasional stone may be slightly projected for increased ruggedness.

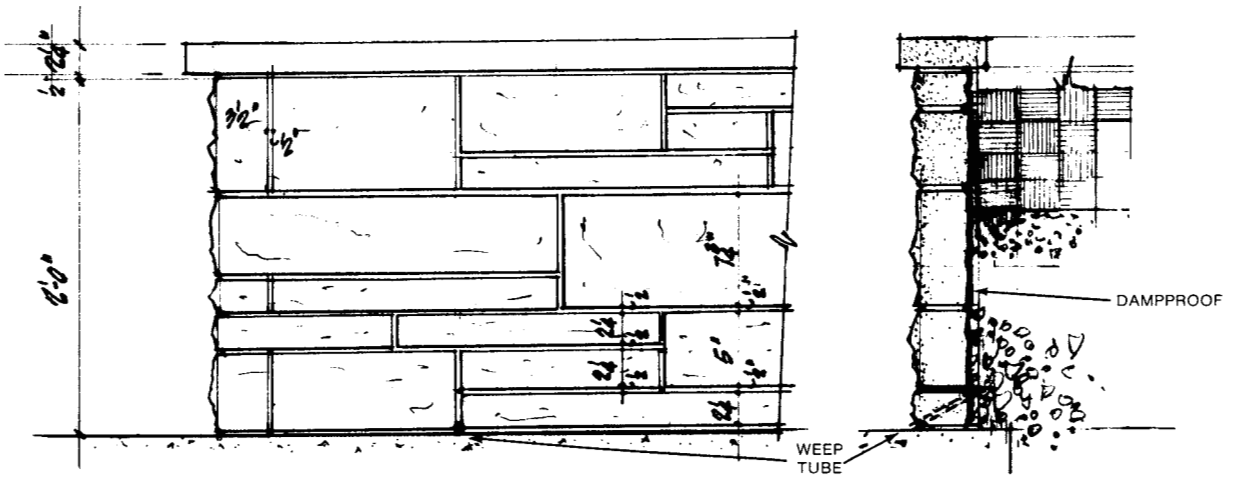

When used as planters or retaining walls, the comparatively formal splitface and other coursed ashlar products should be protected from moisture. Dampproofing on stone or backup and weep holes for drainage should be provided. Dampproofing may consist of waterproof cementitious stone-backing or asphaltic or bituminous material. If possible, joints should be similarly protected, or a waterproof mortar used. Weepholes and gravel fill will help maintain drainage and reduce frost heaving. Perforated footing drain will give added protection.

and predictable stopping surfaces without extra cutting to height. Higher rises of the same module are 10½" and 1'-1¼", which may be used in large blank walls or to give the structure a sense of larger scale. Coursed ashlar stones are usually furnished in random length from 1'-6" to 4'-0"; bed depth (wall thickness) is usually 3" to 4". Stones may be furnished all or mostly jointed (squared) ends, or with naturally broken ends for a more rustic appearance.

Surfaces are generally splitface, or one of the sawed finishes such as chat or shot sawed. The most popular, splitface, is usually considered easier to lay because less care need be taken to preserve sharp edges and corners. Splitface may be hand- or machine-pitched to produce the bolder "rockface" surface by trimming back the "arris" (top and bottom edges of the face). See illustration, p. 4. Varying percentages of the three standard rises may be used, with or without the two higher rises. Standard rise percentages in most coursed ashlar are 15% 2¼", 40% 5" and 45% 7¾". These may be varied both by changing percentages and by adding the higher rises.



Webwall, Drywall & Other Non-Machined Stone

Rough broken slabs of Indiana Limestone with one quarry-split surface may be used in several different setting styles to produce interesting rustic effects. The "webwall" pattern utilizes stones from 2" to 6" thick set vertically. The surface area may vary from less than one to three square feet. The stones have no square corners or straight edges which produces a completely random joint pattern in widths from 1/2" to 2" or more. These stones may be split by machine or hand to a roughly rectangular shape to produce a "rubble" pattern.

These same stones may be set flat (horizontally) to produce a "drywall" appearance.

Originally, a drywall was set without mortar and depended on tightly placed stones for stability. Today, drywalls often are set with mortar, but it is usually kept well back from the surface to give the appearance of mortarless construction. The drywall is especially attractive in landscaping as retaining walls. When used this way, both its foundation and the wall itself should be sloped back at a 10° to 15° angle to resist earth movement. As a veneer, the drywall stones are usually broken to a 3" or 4" wall depth.

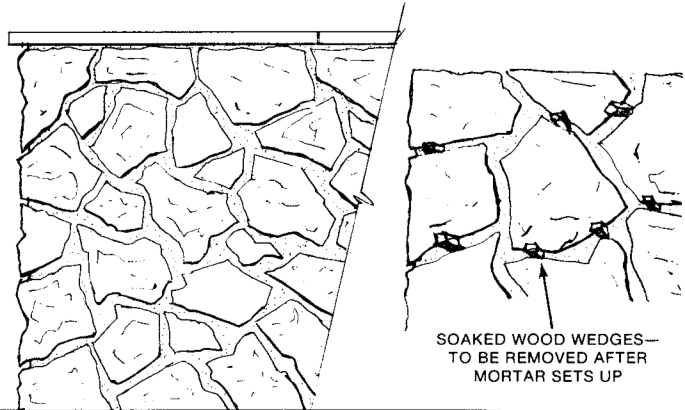

Webwall patterns are attractive and easy to set. The web-wall style is a veneer and must be set against a firm backup and on a solid foundation or ledge. Shaping stones with mallet or chisel can create smaller joints. Wedges may be used occasionally to hold stones in place until mortar sets. Sawed wall coping is particularly effective used with these freeform patterns.

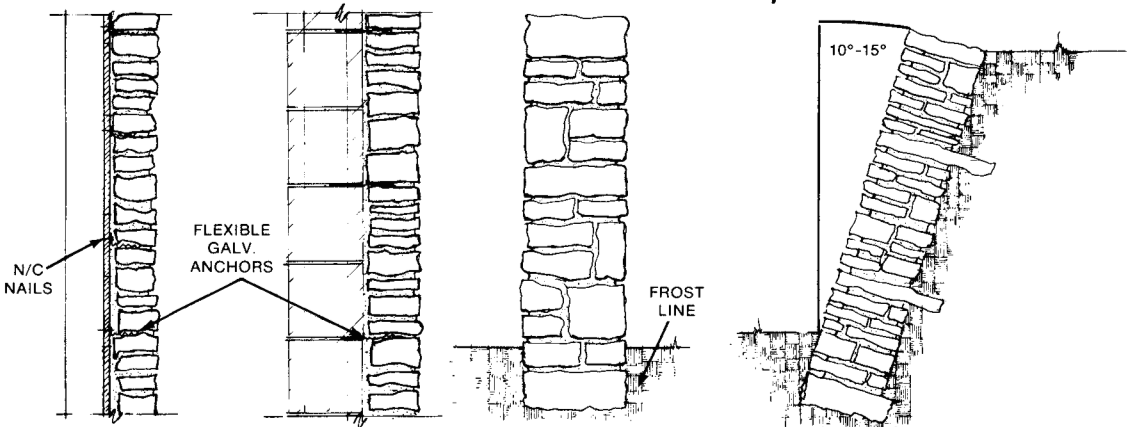

Webwall stones may also be used to produce a "drywall", either free-standing or retaining. Occasionally these stones are roughly squared for a ruggedly handsome pattern. Laid flat, with only sufficient mortar to adjust bearing surface irregularities, this pattern produces an appearance recalling primitive creek-shingle walls of the pioneer wilderness. Retaining walls in the drywall style should be tilted back 10 or 15°. Larger stones used as "deadmen" will help resist frost heaves. Such walls need not be wept.

Grade control with simple, inexpensive retaining walls is both practical and attractive. Dry-set, properly sloped walls form natural terraces and provide planting areas for flowers and ivy.

Specialty Items

Street Furniture, Fountains, Benches, Landscaping, Artwork

The versatility of Indiana Limestone in its standard product form is astonishing. Sill and coping stock slabs may be used as base or starter courses for brick. They may be job-cut into quoins. Brick-sized lengths may be built into a brick wall to delineate an area or to relieve color monotony. A continuous sill course will emphasize horizontal lines and give windows visual support. Platforms and steps of limestone add a note of distinction and long lasting charm.

These same standard products can be sawed by supplier or dealer into a wide variety of decorative and useful building and environmental additions. Simple slab benches are remarkably inexpensive. Sawed stone paving may be bordered with splitface stones set face up.

Imaginative fountains for urban "miniparks" can be designed and built with little or no deviation from standard component sizes, or assembled from the coursed ashlar products and capped with sawed slabs, at such low costs that even municipal budgets remain undisturbed.

Slabs may be used for park walkways and curbing, bases for memorial plaques or assembled into handsome waste receptacle containers. Simple steps to accommodate grade changes are easily cut to length at the site with ordinary masonry saws. This workability, combined with Indiana Limestone's weather and wear resistance, produce designs and uses of almost unlimited application.

Sculpture, whether of a simple, folksy style suitable for informal lawn installations, or of a more cerebral contemporary nature for commercial or domestic decor, is available in standard production and custom designs. Whimsical squirrels or bird baths on classic pedestals—the forms are infinite and many are immediately available. Many fabricators of standard products make such items during slack time and price the items at remarkably low figures for the quality.

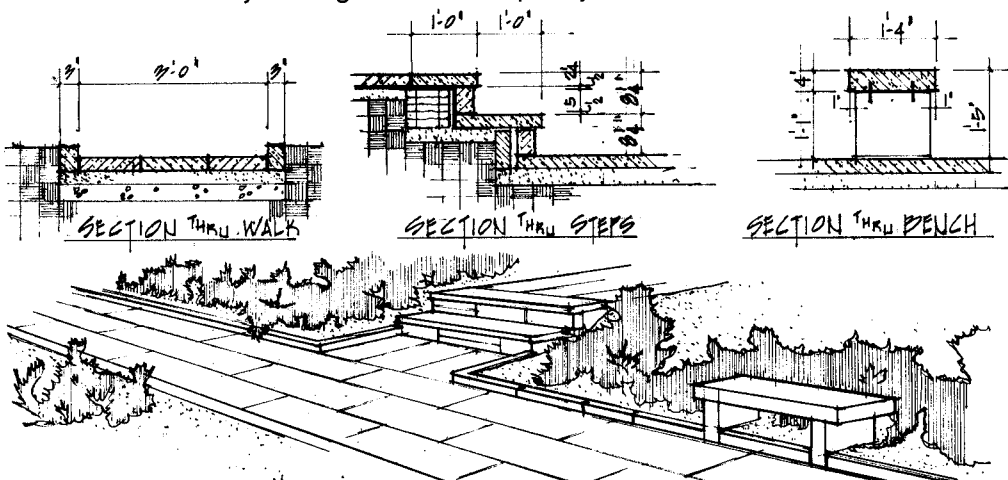

Sawed stone paving, steps and bench present an attractive addition to garden areas or urban parks. Paving may be set on compacted sand and edged with splitface borders. Either splitface or sawed stone may be used as risers for steps. Paving joints may be left open, while treadriser joints should be mortared. Backs of treads rest on scrap stone or block supports.

Joint Styles

The concave joint is most commonly used in unit masonry construction. It is economical to produce and is very weather tight. Each of the other styles shown has its purpose, usually aesthetic, but the importance of final joint tooling or pointing cannot be over-emphasized. This final process gives the joint both its finished look and its weather resistance.

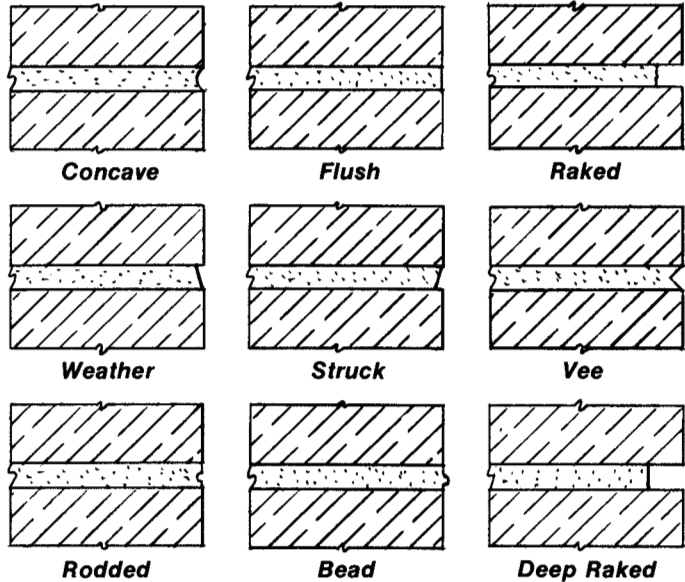

Mortars

Mortars for Indiana Limestone copings, sills and rough or coursed ashlar may be the same for other masonry units. The mix generally recommended (1 part portland cement, 1 part hydrated lime or lime putty and 6 parts sand, all by volume) is an all-around mix with good compression resistance or load-carrying capacity. Gray portland cement (Type II or IIA is usually recommended) may be used with ordinary sand. White portland or masonry mix and white sand will produce a lighter colored mortar for less-prominent joints.

In most unit masonry projects, the setting mortar is also the finished joint material. Joints for Indiana Limestone units may be pointed or tooled in the same way as other masonry units (see joint patterns above). Pointing compresses the mortar and makes the joint watertight. Whatever joint profile is called for, the joint must be well-pointed to be watertight.

Brick walls are about 20% mortar. The typical limestone ashlar wall is less than 12% mortar. In either case, this is a high percentage of wall area over which the mason has control. He is responsible for the mortar mix, its placement and its finishing. Incorrectly mixed mortar will make the best mason look bad, and a poor mason can mess up a job with properly mixed mortar. Mixture, placement and pointing are equally important to a good job.

Mortar qualities in the finished wall include compressive strength (ability to carry vertical loads), bond strength (ability to resist eccentric or lateral loads) and durability (weather or chemical resistance). These qualities vary as the proportions of materials in the mix are adjusted. In order to help builders predict the quality of mortars, and to aid architects in specifying the proper mix for each use, the American Society for Testing and Materials (ASTM) publishes a standard specification for unit masonry mortars, C-270. See chart on page 14.

Of the ASTM mortar types shown, M has high compressive strength and good durability. S has excellent bond and good compressive strength. N has medium compressive and bond strength with excellent durability. This is the most-used type for

exterior veneer and ashlar work. O is a medium-low strength mortar suitable for interior use and load-bearing solid masonry where compressive weights will not exceed about 100 psi. K is a low-strength mortar for non-loadbearing interior uses.

Regardless of the mortar type used, it must be properly and completely mixed. Some masons prefer a slightly stiffer mix for setting stone than would be used for brick and block. Stiff mixtures may be especially useful in setting stone with irregular beds.

As setting proceeds, the mason should take care to remove any unwanted mortar from the stone faces. This is necessary particularly with the more buttery mortars. Final cleaning should be done with fibre brushes and soap powder detergent. Use no acids.

MORTAR PROPORTIONS BY VOLUME

MORTAR TYPE	PARTS BY VOLUME OF PORTLAND CEMENT* OR PORTLAND BLAST FURNACE SLAG CEMENT**	PARTS BY VOLUME OF MASONRY CEMENT	PARTS BY VOLUME OF HYDRATED LIME OR LIME PUTTY	AGGREGATE, MEASURED IN A DAMP, LOOSE CONDITION
M	$\frac{1}{1}$	1 (TYPE II) —	— $\frac{1}{4}$	NOT LESS THAN 2½ AND NOT MORE THAN 3 TIMES THE SUM OF THE VOLUMES OF THE CEMENTS AND LIME USED.
S	$\frac{1/2}{1}$	1 (TYPE II) —	— OVER ¼ to ½	
N	$\frac{—}{1}$	1 (TYPE II) —	— OVER ½ to ¾	
O	$\frac{—}{1}$	1 (TYPE I OR II) —	— OVER 1¼ to 1½	
K	1	—	OVER 2½ to 4	

*TYPES I, II, III, IA, IIA, IIIA **TYPES IS, ISA

Reprinted with permission from the American Society for Testing and Materials, 1916 Race Street, Philadelphia, PA 19103. Copyright.

COLD WEATHER MASONRY CONSTRUCTION AND PROTECTION RECOMMENDATIONS

by the INTERNATIONAL MASONRY INDUSTRY ALL-WEATHER COUNCIL

The consensus of this Council regarding recommendations for cold weather masonry construction and protection are as follows:

WORK DAY TEMPERATURE	CONSTRUCTION REQUIREMENT	PROTECTION REQUIREMENT
Above 40 F	Normal masonry procedures	Cover walls with plastic or canvas at end of work day to prevent water entering masonry.
40 F - 32 F	Heat mixing water to produce mortar temperatures between 40 F - 120 F.	Cover walls and materials to prevent wetting and freezing. Covers should be plastic or canvas.
32 F - 25 F	Heat mixing water and sand to produce mortar temperatures between 40 F - 120 F.	With wind velocities over 15 mph provide wind-breaks during the work day and cover walls and materials at the end of the work day to prevent wetting and freezing. Maintain masonry above freezing for 16 hours using auxiliary heat or insulated blankets.
25 F - 20 F	Mortar on boards should be maintained above 40 F.	
20 F - 0 F and below	Heat mixing water and sand to produce mortar temperatures between 40 F - 120 F.	Provide enclosures and supply sufficient heat to maintain masonry enclosure above 32 F for 24 hours.

Storage & Handling

Most of the products discussed in this book are factory-packaged in strapping or wire or wood baskets on pallets. Ordinarily, no repackaging is required. Occasionally, after long-term storage, some darkening of the stone may be encountered. Exposure to weather, either before or after installation in buildings, will reduce or eliminate these problems. For long-term storage it may be desirable to remove dunnage from the stone to allow air circulation.



Pallets and other packaged stone should be handled carefully by forklift. Rough treatment or too-close stacking in storage yards may produce broken or chipped stones. In most cases, such breakage will not interfere with the use of affected stones except where longer lengths are required for sills and coping runs. Chips can ordinarily be turned toward the wall side.



Pallets may be stacked if the top stones are level, but do not stack more than two or three pallets high. Place spacer skids of pine or cypress between pallets. Wire or wood baskets may bend or break and should not be stacked.

Sawed stone bundles require more careful handling to avoid damage. They may be stacked two high if tops are level. Longer lengths tend to be more valuable at the job, so care should be exercised to avoid breakage.

Break strapping carefully; cut straps rather than twist them loose. Once a bundle or pallet is opened, breakage can occur more easily, so it may be desirable to remove packages from stacking area before opening.

Cleaning finished work.

Final cleandown after all stonework is set is usually done with stiff fiber brushes and plain water. Especially dirty areas may need soap powder or kitchen cleanser. Remove mortar tags when mortar has taken its initial set; smears (from too watery a mortar, from too early tooling or from poor workmanship) should be removed immediately and the joint reworked. Do not use acids on Indiana Limestone for mortar removal or any other purpose.

Waterproofing—Use it or not?

Waterproofing is a general term used to describe the application of clear water repellents. They are applied commonly to brick and other unit masonry walls, and such applications are often useful on Indiana Limestone ashlar and sawed stone trim.

Water repellents can help keep the wall looking dryer and cleaner for extended periods of time. They can be applied to veneer walls where there is no likelihood of water reaching the back sides of treated stones. In the case of retaining walls or

planters of coursed ashlar, either the backup or the stones' backs should be treated with dampproofing (not the same material as water repellent) before surface water repellents are applied.

Drywalls used as retaining walls should not be treated if a rustic, antique look is desired because moisture, moss and vegetable growth will be discouraged.

Preferred water repellent treatments are stearates and acrylics. Silicones may be used but the common 3% to 5% sodium methyl siliconate sometimes causes a discoloration on high-lime substrates.

Like paint, water repellents lose their effectiveness with time and weathering, and will have to be reapplied. Consult manufacturers' representatives for application rates and guarantees.

Beams and Lintels of Indiana Limestone

Total Allowable Uniformly Distributed Load in Pounds Per Inch Width of Lintel

SPAN FEET	HEIGHT OF BEAM OR LINTEL—INCHES													SPAN FEET			
	2	4	6	8	10	12	14	16	18	20	22	24	26		28	30	
1	54	218	494	881	1380	1990	2710	3540	4480	5540	6700	7980	9360	10,900	12,500	1	
2	24	103	238	428	674	976	1330	1750	2210	2740	3320	3950	4640	5390	6190	2	
3	13	62	149	272	433	631	865	1140	1450	1790	2170	2590	3050	3550	4080	3	
4	6	40	101	190	307	452	625	825	1050	1310	1590	1900	2240	2610	3000	4	
5	—	24	70	138	228	340	474	631	810	1010	1230	1480	1750	2040	2350	5	
6	—	13	47	100	171	261	370	497	642	806	988	1190	1410	1650	1900	6	
7	—	—	29	71	128	202	291	396	517	654	806	975	1160	1360	1580	7	
8	—	—	14	47	94	154	228	316	418	534	664	808	966	1140	1320	8	
9	—	—	—	27	64	114	176	251	338	437	549	673	809	958	1120	9	
10	—	—	—	—	9	39	80	132	196	270	356	452	560	679	809	10	
11	—	—	—	—	—	16	50	93	147	211	285	369	463	568	682	11	
12	—	—	—	—	—	—	23	59	104	159	223	296	379	470	571	12	
13	—	—	—	—	—	—	—	27	65	112	167	231	303	384	474	13	
14	—	—	—	—	—	—	—	—	30	69	117	172	235	307	386	14	
15	—	—	—	—	—	—	—	—	—	30	70	118	173	236	306	15	
16	—	—	—	—	—	—	—	—	—	27	68	116	171	233	301	16	
17	—	—	—	—	—	—	—	—	—	—	21	63	110	165	225	17	
18	—	—	—	—	—	—	—	—	—	—	—	12	54	101	154	18	
19	—	—	—	—	—	—	—	—	—	—	—	—	—	—	41	19	
20	—	—	—	—	—	—	—	—	—	—	—	—	—	—	—	25	20

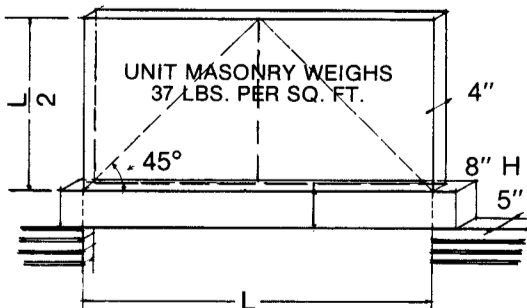

The Beam & Lintel Table is based on a rectangular loading pattern as shown. The actual loading by unit masonry when mortar sets approximates a triangle as

shown by the dotted lines. Therefore, the table is conservative.

Example

L = 5'-0"

H = 8"

Lintel Width = 5"

Maximum allowable load (F):

(F) from table = 138 lbs. per inch width = 138 x 5 = 690

Actual Load:

Unit masonry area = $L \times \frac{L}{2} = 5 \times 2.5 = 12.5 \text{ SF}$

Masonry Weight = 12.5 X 37 = 463

Actual Load = 463 (less than 690—OK)

Nominal Height of Masonry Walls by Courses for Brick & Block

COURSES	REGULAR 4 2¼" bricks + 4 equal joints =					MODULAR 3 bricks + 3 joints =	CONCRETE BLOCKS	
	10"	10½"	11"	11½"	12"	8"	3⅝" blocks	7⅝" blocks
	¼" joints	⅜" joints	½" joints	⅝" joints	¾" joints		⅜" joints	⅜" joints
1	2½"	2⅝"	2¾"	2⅞"	3"	2' 1⅛"	4"	8"
2	5"	5¼"	5½"	5¾"	6"	5' 16"	8"	1' 4"
3	7½"	7⅞"	8¼"	8⅝"	9"	8"	1' 0"	2' 0"
4	10"	10½"	11"	11½"	1' 0"	10' 11/16"	1' 4"	2' 8"
5	1' 0½"	1' 1⅛"	1' 1¾"	1' 2⅜"	1' 3"	1' 15/16"	1' 8"	3' 4"
6	1' 3"	1' 3¾"	1' 4½"	1' 5¼"	1' 6"	1' 4"	2' 0"	4' 0"
7	1' 5½"	1' 6⅜"	1' 7¼"	1' 8⅞"	1' 9"	1' 6' 11/16"	2' 4"	4' 8"
8	1' 8"	1' 9"	1' 10"	1' 11"	2' 0"	1' 9' 16"	2' 8"	5' 4"
9	1' 10½"	1' 11⅝"	2' 0¾"	2' 1⅞"	2' 3"	2' 0"	3' 0"	6' 0"
10	2' 1"	2' 2¼"	2' 3½"	2' 4¾"	2' 6"	2' 2' 11/16"	3' 4"	6' 8"
11	2' 3½"	2' 4⅞"	2' 6¼"	2' 7⅝"	2' 9"	2' 5' 16"	3' 8"	7' 4"
12	2' 6"	2' 7½"	2' 9"	2' 10½"	3' 0"	2' 8"	4' 0"	8' 0"
13	2' 8½"	2' 10⅞"	2' 11¾"	3' 1⅞"	3' 3"	2' 10' 11/16"	4' 4"	8' 8"
14	2' 11"	3' 0¾"	3' 2½"	3' 4¼"	3' 6"	3' 1' 16"	4' 8"	9' 4"
15	3' 1½"	3' 3⅜"	3' 5¼"	3' 7⅞"	3' 9"	3' 4"	5' 0"	10' 0"
16	3' 4"	3' 6"	3' 8"	3' 10"	4' 0"	3' 6' 11/16"	5' 4"	10' 8"
17	3' 6½"	3' 8⅝"	3' 10¾"	4' 0⅞"	4' 3"	3' 9' 16"	5' 8"	11' 4"
18	3' 9"	3' 11¼"	4' 1½"	4' 3¼"	4' 6"	4' 0"	6' 0"	12' 0"
19	3' 11½"	4' 1⅞"	4' 4¼"	4' 6⅝"	4' 9"	4' 2' 11/16"	6' 4"	12' 8"
20	4' 2"	4' 4½"	4' 7"	4' 9½"	5' 0"	4' 5' 16"	6' 8"	13' 4"
21	4' 4½"	4' 7⅞"	4' 9¾"	5' 0⅞"	5' 3"	4' 8"	7' 0"	14' 0"
22	4' 7"	4' 9¾"	5' 0½"	5' 3¼"	5' 6"	4' 10' 11/16"	7' 4"	14' 8"
23	4' 9½"	5' 0⅝"	5' 3¼"	5' 6⅞"	5' 9"	5' 1' 16"	7' 8"	15' 4"
24	5' 0"	5' 3"	5' 6"	5' 9"	6' 0"	5' 4"	8' 0"	16' 0"
25	5' 2½"	5' 5⅝"	5' 8¾"	5' 11⅞"	6' 3"	5' 6' 11/16"	8' 4"	16' 8"
26	5' 5"	5' 8¼"	5' 11½"	6' 2¾"	6' 6"	5' 9' 16"	8' 8"	17' 4"
27	5' 7½"	5' 10⅞"	6' 2¼"	6' 5⅝"	6' 9"	6' 0"	9' 0"	18' 0"
28	5' 10"	6' 1½"	6' 5"	6' 8½"	7' 0"	6' 2' 11/16"	9' 4"	18' 8"
29	6' 0½"	6' 4⅞"	6' 7¾"	6' 11⅜"	7' 3"	6' 5' 16"	9' 8"	19' 4"
30	6' 3"	6' 6¾"	6' 10½"	7' 2¼"	7' 6"	6' 8"	10' 0"	20' 0"
31	6' 5½"	6' 9⅞"	7' 1¼"	7' 5⅞"	7' 9"	6' 10' 11/16"	10' 4"	20' 8"
32	6' 8"	7' 0"	7' 4"	7' 8"	8' 0"	7' 1' 16"	10' 8"	21' 4"
33	6' 10½"	7' 2⅞"	7' 6¾"	7' 10⅞"	8' 3"	7' 4"	11' 0"	22' 0"
34	7' 1"	7' 5¼"	7' 9½"	8' 1¾"	8' 6"	7' 6' 11/16"	11' 4"	22' 8"
35	7' 3½"	7' 7⅞"	8' 0¼"	8' 4⅝"	8' 9"	7' 9' 16"	11' 8"	23' 4"
36	7' 6"	7' 10½"	8' 3"	8' 7½"	9' 0"	8' 0"	12' 0"	24' 0"
37	7' 8½"	8' 1⅞"	8' 5¾"	8' 10⅞"	9' 3"	8' 2' 11/16"	12' 4"	24' 8"
38	7' 11"	8' 3⅜"	8' 8½"	9' 1¼"	9' 6"	8' 5' 16"	12' 8"	25' 4"
39	8' 1½"	8' 6⅞"	8' 11¼"	9' 4⅞"	9' 9"	8' 8"	13' 0"	26' 0"
40	8' 4"	8' 9"	9' 2"	9' 7"	10' 0"	8' 10' 11/16"	13' 4"	26' 8"
41	8' 6½"	8' 11⅝"	9' 4¾"	9' 9⅞"	10' 3"	9' 1' 16"	13' 8"	27' 4"
42	8' 9"	9' 2¼"	9' 7½"	10' 0¾"	10' 6"	9' 4"	14' 0"	28' 0"
43	8' 11½"	9' 4⅞"	9' 10¼"	10' 3⅝"	10' 9"	9' 6' 11/16"	14' 4"	28' 8"
44	9' 2"	9' 7½"	10' 1"	10' 6½"	11' 0"	9' 9' 16"	14' 8"	29' 4"
45	9' 4½"	9' 10⅞"	10' 3¾"	10' 9⅞"	11' 3"	10' 0"	15' 0"	30' 0"
46	9' 7"	10' 0¾"	10' 6½"	11' 0¼"	11' 6"	10' 2' 11/16"	15' 4"	30' 8"
47	9' 9½"	10' 3⅜"	10' 9¼"	11' 3⅞"	11' 9"	10' 5' 16"	15' 8"	31' 4"
48	10' 0"	10' 6"	11' 0"	11' 6"	12' 0"	10' 8"	16' 0"	32' 0"
49	10' 2½"	10' 8⅝"	11' 2¾"	11' 8⅞"	12' 3"	10' 10' 11/16"	16' 4"	32' 8"
50	10' 5"	10' 11¼"	11' 5½"	11' 11¾"	12' 6"	11' 1' 16"	16' 8"	33' 4"

Thermal Properties

'U' factor (the heat transmission coefficient) is the reciprocal of the total resistance (R) to heat transmission of all the materials which make up a finished wall, measured over an area of 1 sq. ft. The formula is expressed as $U = 1/R$ total. In these examples, a constant figure for 4" stone is used to show the comparative values of three types of wall construction:

4" stone	}	U factor = .0517
1" airspace		
3 ⁵ / ₈ " glass-wool bats		
1/2" drywall		
4" stone	}	U factor = .32
1" airspace		
8" concrete		
3/4" M. L. & plaster		
4" stone	}	U factor = .06
2" urethane		
1/2" drywall		

Values of Mass in Thermal Engineering

COURTESY INTERNATIONAL MASONRY INSTITUTE

The 'U' factor is basically a steady-state calculation; that is, it does not consider the dynamics of the total building envelope. An additional consideration in thermal calculations is the effect of mass in heat transmission. Heavy walls exhibit a "fly-wheel" effect which retards the immediate impact of thermal loads. Massy materials, such as

The "M" Factor

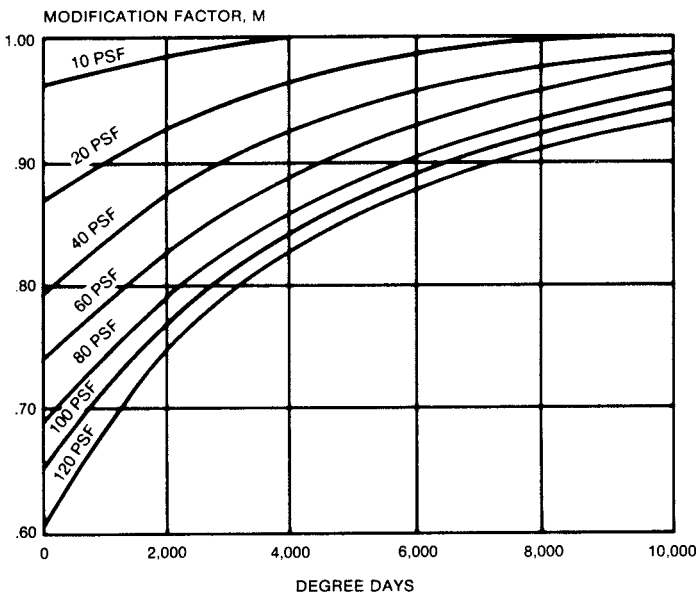

How To Figure Heat Loss

The formula for calculating heat loss that allows for the thermal retention effects of mass is as follows:

$$H_1 = MAU (t_i - t_o)$$

where:

H_1 = heat loss transmitted through the walls or other elements of the building envelope, Btu per hour.

M = modification factor taken from graph at left according to degree days of building location and weight of building walls or other elements.

A = area of the walls or other elements, square feet.

U = overall coefficient of transmission of the walls or other elements, Btu per hour per square foot per degree F temperature difference.

t_i = indoor design temperature, degrees F.

t_o = outdoor design temperature, degrees F.

Indiana Limestone, react slowly to temperature changes which amounts to an inertial resistance to change. This creates a time lag which is advantageous in designing HVAC systems.

Storage capacity in the building envelope reduces the structure's maximum heat flow and thereby the peak-load which determines the size requirement of the HVAC equipment. Buildings with walls exhibiting poor thermal storage capacity require larger equipment to maintain a stated design temperature; the larger the storage capacity of the exterior walls, the smaller and less expensive the HVAC system needed. Heat stored in massy walls tends to be transmitted in low-load time, and in many locations actually reduces the required night HVAC requirements.

The 'M' factor is demonstrated in the accompanying graph. Based on degree days and wall mass expressed in pounds per square foot, the graph, used in conjunction with the heat loss formula allows calculation of thermal storage values in walls of varying weights. Note that the correction values are conservative and propose the least amount of change to be considered. Where specific information for any area shows that lower correction values are applicable, they may be substituted.

Color Value

The chart below illustrates the value of heavy, light-colored walls in air conditioning engineering. During the crucial mid-afternoon hours, west walls in identical locations register temperature differentials of more than 25° F based entirely on their color and mass.

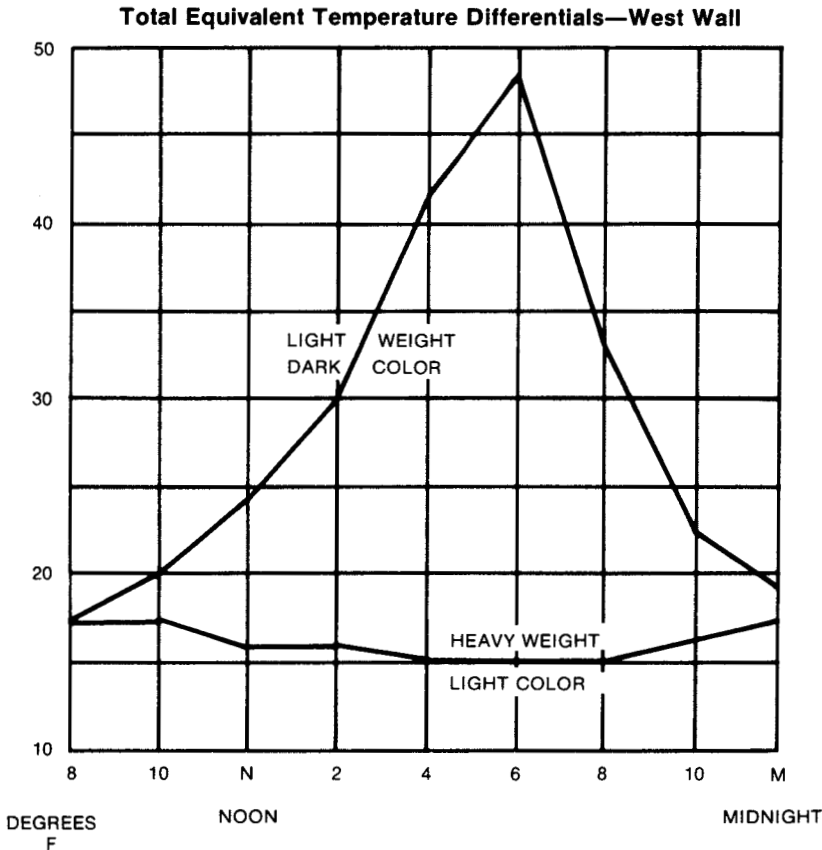

Geological Formation

Indiana Limestone (from the formation known as the Salem Limestone) is essentially monomineralic rock consisting of the calcium carbonate (CaCO_3) mineral named calcite. The calcite comes from the skeletons of the marine organisms that help to form Indiana Limestone and is the cementing material that binds these skeletons together. More than half of the deposit of Indiana Limestone is composed of these small sea shells; the remainder consists of cementing material and a very minute quantity of noncalcareous minerals.

Indiana Limestone was formed in a shallow sea that covered the Midwest, including the Bedford-Bloomington, Indiana quarry area, more than 300 million years ago during the Mississippian geological epoch. This shallow sea was inhabited by a vast number of shell-protected organisms, chiefly bryozoans and echinoderms, although many members of a single genus of the foraminifers were also present. Shellfish of the brachiopods and mollusks and a few other forms of life also lived in the sea. The shells were moved, broken, crushed and ground, then redeposited through the action of the currents. Finely-divided calcium carbonate was produced during this process and adhered to many shells in a series of concentric layers to form oolitic (rock egg) grains, so named because of a resemblance to roe of fish.

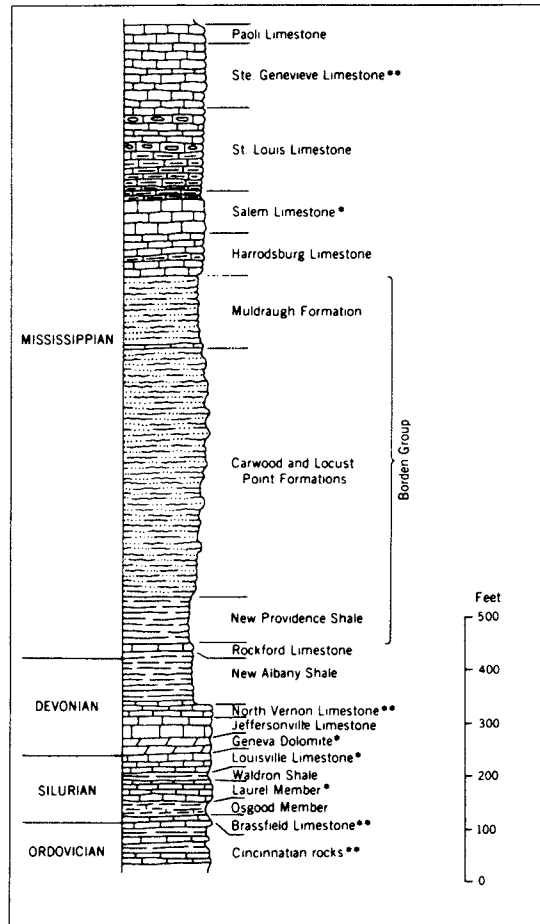

Figure 1. Stratigraphic section showing important dimension limestones in Indiana.

Courtesy of Indiana Geological Survey

As these particles accumulated and were buried on the floor of the sea, they were incorporated into rock through compaction, interlocking of grains, and cementation of the grains by enlargement of finely-divided crystals either deposited with the shells or precipitated from supersaturated solution.

Physical Properties

PROPERTY	VALUE	TEST PROCEDURE
Ultimate compressive strength dry specimens	4,000 psi minimum (see note a)	ASTM C170
Modulus of rupture dry specimens	700 psi minimum (see note a)	ASTM C99
Absorption	7½% maximum	ASTM C97

Note a: Most Indiana Limestone production possesses values higher than these minimums, which are listed for engineering reference. Special hard stones are produced by several quarry sources. Use a safety factor of 8 to determine working stress.

Chemical Analysis

The average analysis as developed by carefully prepared composite samples is given below.

	BUFF	GRAY
Carbonate of Lime	97.39	97.07
Carbonate of Magnesia	1.20	1.20
Silica	.69	.80
Alumina	.44	.68
Iron Oxide	.18	.12
Water and Loss	<u>.10</u>	<u>.13</u>
	100.00	100.00

Product Description

Indiana Limestone is a calcite-cemented calcareous stone formed of shells and shell fragments, practically non-crystalline in character. It is found in massive deposits located almost entirely in Lawrence, Monroe, and Owen counties in Indiana. This limestone is characteristically a free-stone, without pronounced cleavage planes, possessing a remarkable uniformity of composition, texture, and structure. It has a high internal elasticity, adapting itself without damage to extreme temperature changes.

This stone combines excellent physical properties with a remarkable degree of machinability. This ease of machining provides complete flexibility of shape and texture at low cost.

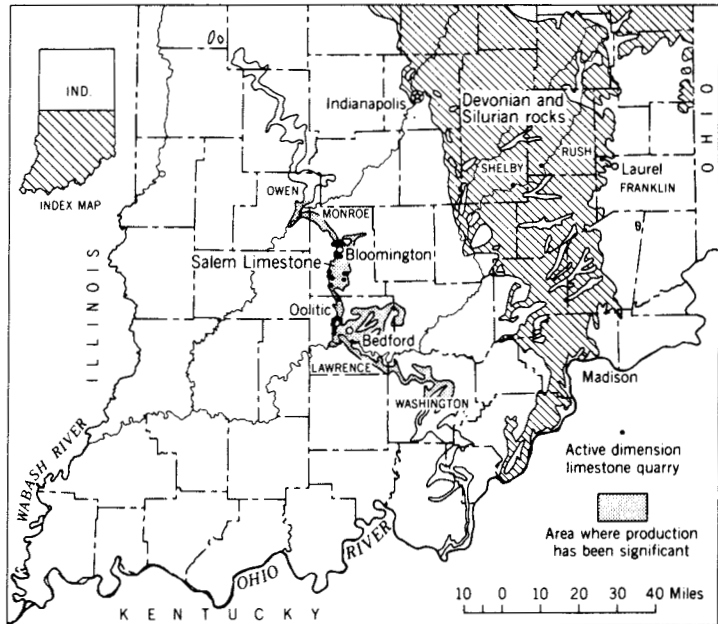

Figure 2. Map showing outcrop areas of the Salem Limestone and Devonian and Silurian carbonate rocks in southern Indiana and locations of quarries.

Courtesy of Indiana Geological Survey

Colors

Indiana Limestone ashlar and sawed stone is available in two color ranges, Buff and Gray. The Buff color-tones range from off-white to egg-shell, and the Gray from light-silver to medium gray. A combination of the two is called Variegated. Users may receive the full range of color-tones within either color range as no selection within the color specified will be made. Orders specifying Variegated stone will contain an uncertain percentage of individual stones showing both colors. Most stones will be either all Buff or all Gray, and the supplier will usually attempt to ship equal quantities of each, unless percentages are specified.

Specifications for Ashlar Stone Veneer and Sawed Stone Trim

Note: This specification should be included in Sec. 4 "Masonry" adjacent to but separate from any specification for Cut Stone.

1. Work included

The work included in this section shall include all labor and material for the furnishing and setting of all interior and exterior Indiana Limestone Ashlar Veneer and Sawed Stone Trim in accordance with drawings.

2. Stone

- A. General. Stone shall be (coursed ashlar) (webwall) (drywall)—specify—Indiana Limestone quarried in Lawrence and Monroe County and produced by a member of the Indiana Limestone Institute.
- B. Color. The stone shall be (unselected for color) (all buff) (all gray) (____ % buff and ____ % gray)—specify.

(use following for Coursed Ashlar only)

- C. Finish. The face surface of the stone shall be (splitface) (shotsawed) (chatsawed)—specify.
- D. Dimensions.
1. Bed thickness shall be between 3" and 4".
 2. Course heights shall be furnished in the following percentages: 15%—2 $\frac{1}{4}$ "; 40%—5"; 45%—7 $\frac{3}{4}$ ". (Specify other percentages and rises.)
 3. Stone lengths shall be random, varying between 1'-6" and 4'-0", and shall be jointed at the job to lengths conforming to approved jointing pattern.

(use following for Webwall and Drywall only)

- C. Finish. The face surface of the stone shall be rough broken.
- D. Dimensions.
1. (Webwall only) Bed thickness shall be between 2" and 6".
(Drywall only) Bed thickness shall be _____ (specify: between 3" and 4" when used as veneer; random, varying between 4" and 2'-0" when used as full-thick or retaining wall).
 2. (Webwall only) Exposed faces shall vary from one-half to three square feet.
(Drywall only) Exposed stone edges shall vary between 2" and 6" high.
- E. Sawed Stone sills and coping
These items shall be (specify color) Indiana Limestone sawed or otherwise dimensioned to the sizes shown on drawings, and anchored as shown or as detailed in large scale sections.

(following applies to all types)

3. Setting stonework

- A. Stone shall be set in strict accordance with approved profile and jointing pattern. Joints shall be _____" wide (specify)
- B. Stone shall be anchored with non-corrosive wall ties spaced not over 18" horizontally and 24" vertically.

4. Mortar

Mortar shall (be as specified for other masonry units) (conform to Type _____ (specify), ASTM C-270 requirements) with final color to be approved by architect.

5. Handling and storage

All Indiana Limestone shall be shipped, unloaded and stored in such a manner as to avoid excess breakage and stain. Stone shall be stored at the job on planks, pallets, or timbers, clear of soil and soil splash.

6. Cleaning

Finished stonework shall be washed clean and free of dirt, mortar and other objectionable accumulations. Remove mortar droppings and smears as work progresses. Final cleanup shall include brushing with fibre brushes and mild soap or detergent, and rinsing with clear water. Use no acids without prior approval. Protect stonework from rundown or splash when using acid on adjacent materials.

Indiana
Limestone
Institute

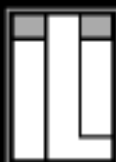

The coordinating agency
for information, education,
and technical data for
Indiana Limestone, the
Nation's Building Stone.